



BASI TAVOLO
TABLE BASES

Concedetevi il lusso | Treat yourself to luxury



BESENZONI'S WORLD



Besenzoni da oltre 55 anni si è affermata come una delle principali aziende nel settore nautico rappresentando con orgoglio il Made in Italy. Il costante aggiornamento tecnologico le permette di offrire sette collezioni di accessori per yacht con un catalogo che conta più di 170 prodotti standard. Besenzoni si distingue anche per la capacità di realizzare soluzioni su misura adattandosi con precisione alle esigenze specifiche dei suoi clienti. L'approccio flessibile consente all'azienda di soddisfare richieste personalizzate dimostrando una grande attenzione ai dettagli. L'azienda vanta inoltre una rete commerciale estesa e consolidata, con 160 unità operative distribuite in cinque continenti garantendo un supporto diretto e tempestivo in ogni parte del mondo.

Besenzoni, for over 55 years, has established itself as one of the leading companies in the nautical sector, proudly representing Made in Italy. Continuous technological updates allow it to offer seven collections of yacht accessories with a catalog featuring more than 170 standard products. Besenzoni also stands out for its ability to create custom solutions precisely adapting to the specific needs of its customers. The flexible approach allows the company to meet personalized requests, demonstrating great attention to detail. Additionally, the company boasts an extensive and well-established commercial network, with 160 operational units distributed across five continents, ensuring direct and timely support in every part of the world.

Ufficio Vendite *Sales Dept*

tel. +39 035 910456 r.a. - fax +39 035 4261633
e-mail: info@besenzoni.it

Servizio Clienti *Customer Service*

tel. +39 035 4262938 - fax +39 035 4261633
e-mail: customer.service@besenzoni.it



Vendita/Assistenza
Sales/Assistance



Supporti tavolo Table pedestal

Vasta gamma di supporti tavolo con movimentazione idraulica, elettrica, manuale, con pistone a gas o fisso per poter soddisfare ogni tipo di necessità a bordo.

Le Basi Tavolo sono prodotte con strutture in acciaio inox lucido o verniciato o in lega leggera verniciata, complete di telescopici orizzontali per il sostegno del piano tavolo.

Wide range of table supports with hydraulic movement, electric, manual, with gas piston or fixed to meet all kinds of needs on board. Table Bases are produced with polished or painted stainless steel or painted light alloy structures, complete with horizontal telescopic supports for supporting the table top.



T 601

- Supporto tavolo a tre stadi con movimento oleodinamico
- Struttura in lega leggera verniciata opaca
- Sistema di sicurezza anti-schiacciamento montato sulla centralina idraulica
- Installazione sotto pagliolo

- Three stage hydraulic table pedestal
- Coated aluminium structure
- Safety device fitted to power pack to prevent any harm during lowering
- Recessed model

A mm	500x300
B mm	Ø 250
h mm	230
H mm	740
h1 mm	210
T mm	Ø 130
Weight kg	30
Lifting capacity kg	70

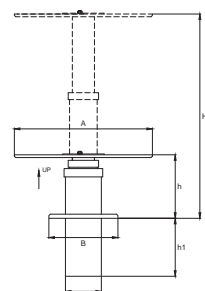

T 275

- Supporto tavolo in acciaio lucido o verniciato
- Movimentazione elettrica per scorrimento verticale
- Sezione circolare
- Piastre superiore ed inferiore in acciaio
- Centralina elettrica 24V

- Table support made in polished or coated stainless steel
- Electric movement for the vertical stroke
- Circular section
- Upper and lower plates made in stainless steel
- Electric unit 24V

A mm	Ø 400
B mm	Ø 400
h mm	340
H mm	640
Weight kg	35
Lifting capacity kg	180

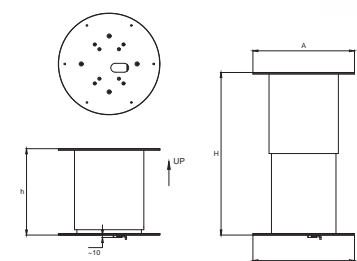

T 276

- Supporto tavolo in acciaio lucido o verniciato
- Movimentazione elettrica per scorrimento verticale
- Sezione quadrata
- Piastre superiore ed inferiore in acciaio
- Centralina elettrica 24V

- Table support made in polished or coated stainless steel
- Electric movement for the vertical stroke
- Square section
- Upper and lower plates made in stainless steel
- Electric unit 24V

A mm	400x400
B mm	400x400
h mm	340
H mm	640
Weight kg	37
Lifting capacity kg	180

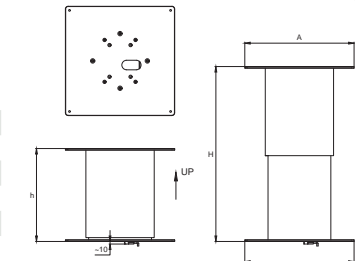

T 139 O

- Supporto tavolo pozzetto a scomparsa con movimento oleodinamico
- Struttura in acciaio inox verniciato
- Sistema di sicurezza anti-schiacciamento montato sulla centralina idraulica

- Folding hydraulic cockpit table pedestal
- Powder coated stainless steel structure
- Safety device fitted to power pack to prevent any harm during lowering

A mm	960
B mm	1000
E mm	315
F mm	350
h mm	140
H mm	730
Weight kg	12
Lifting capacity kg	60

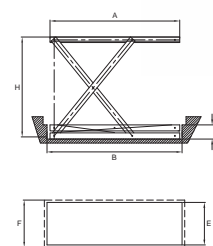

T 139 E

- Supporto tavolo pozzetto a scomparsa
- Struttura in acciaio inox verniciato
- Movimento elettrico per scorrimento verticale

- Folding cockpit table pedestal
- Powder coated stainless steel structure
- Electric handling for vertical sliding

A mm	960
B mm	1000
E mm	315
F mm	350
h mm	140
H mm	730
Weight kg	12
Lifting capacity kg	40

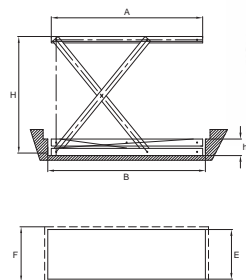

T 277

- Supporto tavolo in acciaio lucido o verniciato
- Movimentazione elettrica per scorrimento verticale
- Sezione circolare
- Piastre superiore ed inferiore in acciaio
- Centralina elettrica 24V

- Table support made in polished or coated stainless steel
- Electric movement for the vertical stroke
- Circular section
- Upper and lower plates made in stainless steel
- Electric unit 24V

A mm	Ø 400
B mm	Ø 400
h mm	380
H mm	730
Weight kg	35
Lifting capacity kg	180

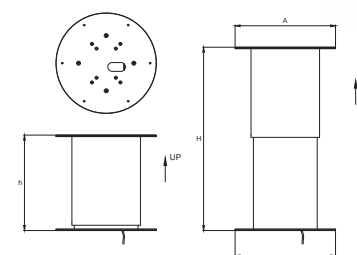

T 278

- Supporto tavolo in acciaio lucido o verniciato
- Movimentazione elettrica per scorrimento verticale
- Sezione quadrata
- Piastre superiore ed inferiore in acciaio
- Centralina elettrica 24V

- Table support made in polished or coated stainless steel
- Electric movement for the vertical stroke
- Square section
- Upper and lower plates made in stainless steel
- Electric unit 24V

A mm	400x400
B mm	400x400
h mm	380
H mm	730
Weight kg	37
Lifting capacity kg	180

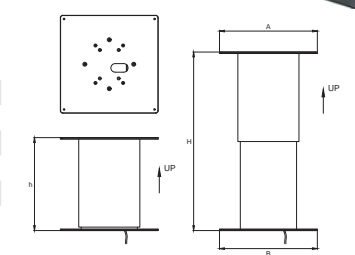

T 260

- Supporto tavolo a scorrimento elettrico
- Piastra superiore e inferiore in acciaio inox lucido
- Rivestimento sezione centrale in sky o pelle
- Idoneo per interni
- Optional: senza rivestimento
- Centralina elettrica 24V

- Electric table pedestal*
- Polished stainless steel telescopic section and both plates*
- Vinyl or real leather covering to central section*
- Suitable for interiors*
- Optional: without upholstery*
- Electric unit 24V*

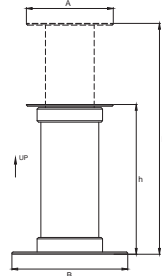

A mm	Ø 300
B mm	Ø 400
h mm	520
H mm	770
Weight kg	30
Lifting capacity kg	60

T 271

- Supporto tavolo a due stadi in alluminio verniciato e basi in acciaio lucido
- Scorrimento elettrico
- Gestione dei movimenti tramite scheda elettronica
- Sistema di sicurezza anti-schiacciamento
- Centralina elettrica 24V

- Two stages electric table pedestal with coated aluminium structure and polished stainless steel bases*
- Controlled via circuit board*
- Safety device fitted to power pack to prevent any harm during lowering*
- Electric unit 24V*

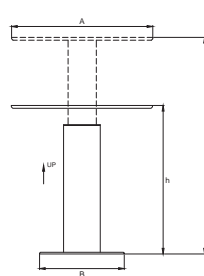

A mm	500x300
B mm	Ø 300
h mm	520
H mm	765
Weight kg	15
Lifting capacity kg	100

T 132 MG

- Supporto in lega leggera verniciata
- Movimento a gas per scorrimento verticale
- Girevole a 360°
- Sistema di regolazione altezza con maniglia

- Coated aluminium table pedestal*
- Gas assisted vertical movement*
- Manually height adjustable via lever*
- 360° rotation*

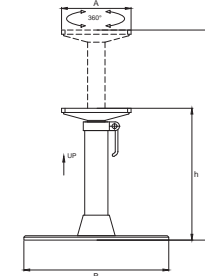

A mm	240x240
B mm	500x500
h mm	460
H mm	730
Weight kg	16,5
Lifting capacity kg	20

T 232 MG

- Supporto in lega leggera, con inserti in acciaio lucido
- Movimento a gas per scorrimento verticale
- Girevole a 360°
- Sistema di regolazione altezza con maniglia

- Coated aluminium table pedestal with polished stainless steel inserts*
- Gas assisted vertical movement*
- Manually height adjustable via lever*
- 360° rotation*

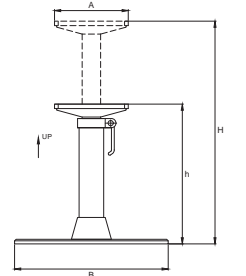

A mm	240x240
B mm	500x500
h mm	460
H mm	730
Weight kg	16
Lifting capacity kg	20

T 248 MG

- Supporto tavolo con struttura in alluminio verniciato e base inferiore quadrata
- Movimento a gas per scorrimento verticale
- Sistema di regolazione altezza con maniglia
- Girevole a 360°

- Coated aluminium telescopic pedestal with squared base*
- Gas assisted vertical movement*
- Manually height adjustable via lever*
- 360° rotation*

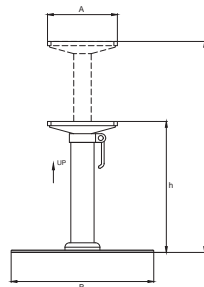

A mm	240x240
B mm	490x490x8
h mm	450
H mm	725
Weight kg	20
Lifting capacity kg	20

T 131 MG

- Supporto tavolo in alluminio verniciato, in due versioni: fisso e asportabile
- Movimento a gas per scorrimento verticale
- Sistema di regolazione altezza con maniglia
- Base regolabile in altezza per predisposizione sottopagliolo
- Girevole a 360°

- Coated aluminium table pedestal: fixed and removable version*
- Gas assisted vertical movement*
- Manually height adjustable via lever*
- Adjustable in height to go below the deck*
- 360° rotation*



F = fisso - fixed
A = asportabile - asportable

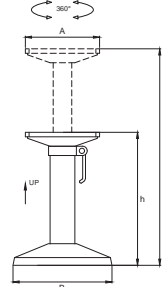

A mm	240x240
B mm	Ø 320
h mm	430
H mm	720
Weight kg	7
Lifting capacity kg	20

T 133 MG

- Supporto tavolo in lega leggera verniciata
- Movimento a gas per scorrimento verticale
- Regolabile in altezza con volantino, girevole a 360°
- Dotato di telescopici orizzontali per il sostegno del piano tavolo aperto

- Coated aluminium table pedestal*
- Gas assisted vertical movement, 360° rotation*
- Adjustable in height via thumbwheel*
- Manually adjustable telescopic table leaf supports*

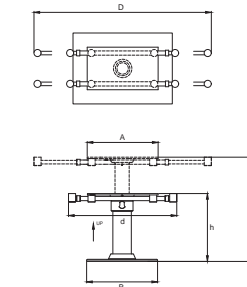

A mm	500x300
B mm	700x500
d mm	790
D mm	1250
h mm	480
H mm	730
Weight kg	28
Lifting capacity kg	20
Opt. Lifting capacity kg	35

T 233 MG

- Supporto in lega leggera con inserti in acciaio inox lucido
- Movimento a gas per scorrimento verticale
- Regolabile in altezza con volantino, girevole a 360°
- Dotato di telescopici orizzontali per il sostegno del piano tavolo aperto

- Coated aluminium table pedestal with polished stainless steel inserts*
- Gas assisted vertical movement, 360° rotation*
- Adjustable in height via a thumbwheel*
- Manually adjustable telescopic table leaf supports*

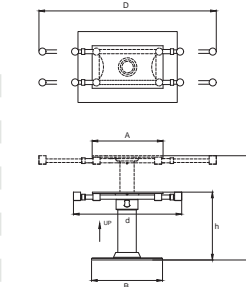

A mm	500x300
B mm	700x500
d mm	790
D mm	1250
h mm	480
H mm	730
Weight kg	28
Lifting capacity kg	20
Opt. Lifting capacity kg	35

T 137 MG



- Supporto tavolo in lega leggera verniciata con base quadrata
- Movimento a gas per scorrimento verticale
- Regolabile in altezza con volantino e girevole a 360°
- Optional: struttura con base tonda



- Coated aluminium table pedestal with squared base
- Gas assisted vertical movement
- Adjustable in height via a thumbwheel 360° rotation
- Optional: round base

A mm	500x300
B mm	500x500
h mm	485
H mm	742
Weight kg	24
Lifting capacity kg	20
Opt. Lifting capacity kg	35

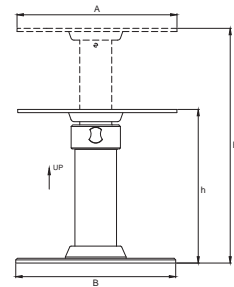

T 237 MG

- Supporto in lega leggera verniciata con inserti in acciaio inox lucido
- Movimento a gas per scorrimento verticale
- Regolabile in altezza con volantino e girevole di 360°



- Coated aluminium table pedestal with polished stainless steel inserts
- Gas assisted vertical movement
- Adjustable in height via a thumbwheel
- 360° rotation

A mm	500x300
B mm	500x500
h mm	485
H mm	742
Weight kg	24
Lifting capacity kg	20
Opt. Lifting capacity kg	35

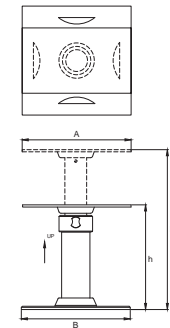

T 240 MG

- Supporto tavolo in alluminio verniciato con base rotonda
- Movimento a gas per scorrimento verticale
- Sistema di regolazione altezza con maniglia
- Girevole a 360°



- Coated aluminium table pedestal with round base
- Gas assisted vertical movement
- Manually height adjustable via lever
- 360° rotation

A mm	240x240
B mm	Ø 330
h mm	430
H mm	720
Weight kg	6
Lifting capacity kg	20

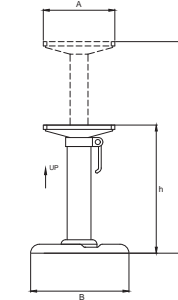

T 241 MG

- Supporto tavolo in alluminio verniciato con base quadrata
- Movimento a gas per scorrimento verticale
- Sistema di regolazione altezza con maniglia
- Girevole a 360°



- Coated aluminium table pedestal with square base
- Gas assisted vertical movement
- Manually height adjustable via lever
- 360° rotation

A mm	240x240
B mm	Ø 330
h mm	430
H mm	720
Weight kg	6
Lifting capacity kg	20

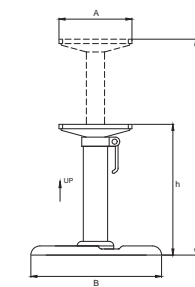

T 138 MG

- Supporto in alluminio verniciato opaco, con doppia colonna
- Movimento a gas per scorrimento verticale
- Sistema di regolazione altezza con maniglia



- Twin column coated aluminium table pedestal
- Gas assisted vertical movement
- Manually height adjustable via lever

A mm	240x240
B mm	900x300
D mm	600
h mm	450
H mm	720
Weight kg	19
Lifting capacity kg	40
	20 each

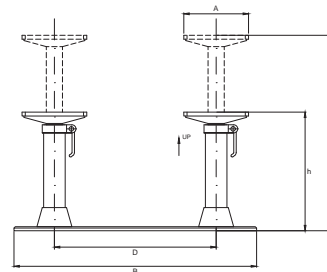

T 238 MG

- Supporto in alluminio verniciato a doppia colonna con inserti in acciaio lucido
- Movimento a gas per scorrimento verticale
- Sistema di regolazione altezza con maniglia



- Twin column coated aluminium table pedestal with polished stainless steel inserts
- Gas assisted vertical movement
- Manually height adjustable via lever

A mm	240x240
B mm	900x300x10
D mm	600
h mm	455
H mm	725
Weight kg	19
Lifting capacity kg	40
	20 each

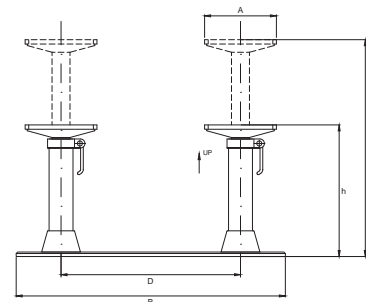

T 112

- Supporto tavolo in alluminio verniciato, in due versioni: fisso e asportabile
- Movimento manuale per scorrimento verticale
- Sistema di regolazione altezza con maniglia
- Base regolabile in altezza per predisposizione sottopagliolo
- Girevole a 360°



- Coated aluminium table pedestal: fixed and removable version
- Manual vertical movement
- Manually height adjustable via lever
- 360° rotation
- Adjustable in height to go below the deck

A mm	240x240
B mm	Ø 280
h mm	410
H mm	700
Weight kg	6

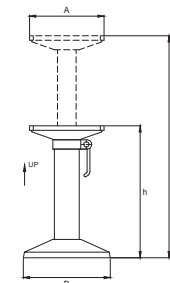

T 265

- Supporto tavolo fisso
- Struttura in acciaio inox lucido
- Idoneo sia per interni che per esterni



- Fixed table pedestal
- Polished stainless steel structure
- Suitable for internal and external use

A mm	Ø 400
B mm	Ø 500
H mm	750
T mm	Ø 275
Weight kg	35

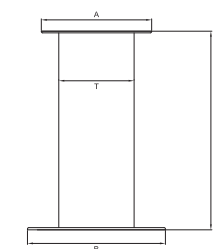



Condizioni generali di Vendita, Assistenza e Garanzia.

Il testo completo delle Condizioni generali di Vendita dei prodotti sono riportate in un documento allegato alla conferma d'ordine del produttore. I termini e le Condizioni di Garanzia sono contenuti nella confezione del prodotto acquistato o riportati nei libretti di istruzione. Tutte le fotografie, le descrizioni e i dati tecnici dei prodotti presenti in questo catalogo sono da intendersi puramente indicative e possono essere soggette a variazioni senza preavviso; per avere informazioni più dettagliate e precise sui prodotti vi preghiamo di contattare Besenzone S.p.A. Tutte le fotografie, i testi, i disegni e le tabelle tecniche sono stati concepiti da Besenzone S.p.A. che ne conserva il diritto intellettuale, così come previsto dalle leggi vigenti. L'utilizzo di materiali in qualsiasi forma contenuti nel catalogo è tutelato dalle leggi italiane e internazionali sul diritto d'autore. Qualsiasi violazione dei diritti esclusivi spettanti a Besenzone S.p.A. in relazione ai contenuti citati e ogni utilizzo diverso da quello descritto sono vietati e verranno sanzionati e perseguiti nei termini stabiliti dalla legge sul diritto d'autore. Tutti gli articoli presenti in questo catalogo sono progettati e realizzati per un utilizzo conforme alle loro specifiche finalità.

General Sales Conditions, After-Sales Service and Warranty.

The full text of the General Sales Conditions for the products is shown in a document attached to the manufacturer's order confirmation. The Warranty Conditions are contained in the pack of the product purchased or are shown in the instruction books. All the product photos, descriptions and technical data appearing in this catalogue are purely indicative and may be subject to change without prior notice; for more detailed and accurate information on products, please contact Besenzone S.p.A. All photos, texts, drawings and technical tables have been conceived by Besenzone S.p.A. which retains their intellectual property rights, in accordance with current legislation. The use of materials contained in the catalogue, in any form, is protected by Italian and International copyright laws. Any violation of exclusive rights belonging to Besenzone S.p.A. in relation to the above-mentioned content and any use other than that described is prohibited and will be subject to sanctions and legal action, in accordance with the terms established by copyright law.

All articles in this catalog are designed and manufactured for use in accordance with their specific purposes.

Si ringrazia per la gentile concessione del materiale fotografico:

Thanks for the kind concession of the photographic material:

Absolute S.p.A. ↓ Alexander Marine ↓ Amer ↓ Arno Cantiere Navale ↓ Azimut - Benetti S.p.A. ↓ Beneteau S.a. Chantiers ↓ Bilgin Yachts ↓ Canados International ↓ CNB ↓ Cranchi S.p.A. Cantiere Nautico ↓ CRN S.p.A. ↓ Custom Line ↓ DL Yachts ↓ Dominator S.r.l. ↓ Fairline Yachts ↓ FB design srl ↓ Ferretti Group ↓ Fiart ↓ Galeon Yacht ↓ Hanse Group ↓ Horizon Yacht ↓ Hudson Yacht ↓ Itama S.p.A. ↓ Mazu Yachts ↓ Nautor's Swan ↓ Numarine ↓ Palmer & Johnson Yachts ↓ Pershing S.p.A. ↓ Prestige Yachts ↓ Sanlorenzo S.p.A. ↓ Sirena yachts ↓ Sunreef yachts ↓ Sunseeker yachts

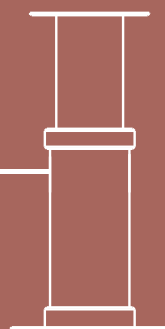

via Molere 2 † 24067 Sarnico BG † ITALY
ph. +39 035 910456 r.a. † info@besenzoni.it

WWW.BESENZONI.IT